

GB

**Cylinder Shape Burs with Radius End
Solid Carbide**

* 8mm shanks optional

To Order Optional Cuts 4, 3SP, 2, 5 – Specify
Quantity, Tool No. & Optional cut

ES

Tool No.	Ød1 mm	Ød2 mm	l1 mm	l2 mm
SC-1	6	2	55	10
SC-2	6	3	55	14
SC-3	6	4	55	14
SC-4	6	6	65	16
SC-5	6	8	65	20
SC-6	6	10	65	20
SC-7	6	12	65	25
SC-8	6	16	65	25

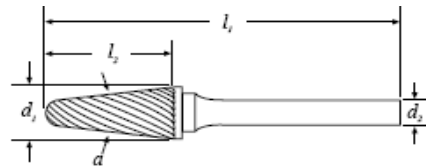

GB

**Taper with Radius End Burs
Solid Carbide**

* 8mm shanks optional. To Order Optional Cuts

4, 3SP, 2, 5 - Specify Quantity, Tool No. &
Optional Cut

ES

Limas rotativas cónicas a 8°-14° punta



Tool No.	Ød1 mm	Ød2 mm	l1 mm	l2 mm
SL-1	6	3	55	13
SL-2	6	6	65	16
SL-3	6	8	65	22
SL-4	6	10	65	25
SL-6	6	12	80	28
SL-7	6	16	80	33

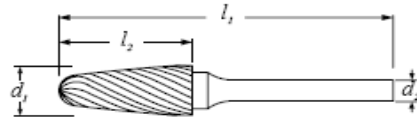

GB

Tree Shape Burs with Radius End

Solid Carbide

* 8mm shanks optional

To Order Optional Cuts 4, 3SP, 2, 5 – Specify Quantity, Tool No. & Optional cut

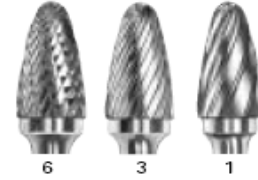

ES

Tool No.	Ød1 mm	Ød2 mm	l1 mm	l2 mm
SF-1	6	3	55	13
SF-3	6	6	65	18
SF-4	6	8	65	20
SF-5	6	10	65	20
SF-6	6	12	65	25
SF-7	6	16	65	25

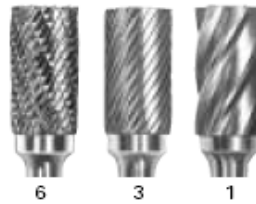
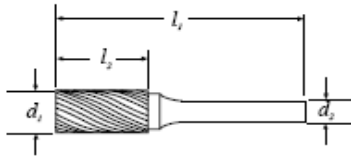

GB

Cylinder Shape Burs

Solid Carbide

* 8mm shanks optional

To Order Optional Cuts 4, 3SP, 2, 5 – Specify Quantity, Tool No. & Optional cut

Tool No.	Ød1 mm	Ød2 mm	l1 mm	l2 mm
SA-1	6	2	55	10
SA-2	6	3	55	14
SA-3	6	4	55	14
SA-4	6	6	65	16
SA-5	6	8	65	20
SA-6	6	10	65	20
SA-7	6	12	65	25
SA-9	6	16	65	25

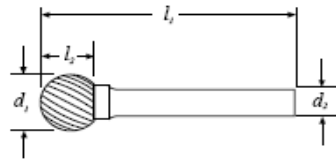

GB

Ball Shape Burs
Solid Carbide

* 8mm shanks optional

To Order Optional Cuts 4, 3SP, 2, 5 – Specify Quantity, Tool No. & Optional cut



ES

Tool No.	Ød1 mm	Ød2 mm	l1 mm	l2 mm
SD-1	6	2	55	1.8
SD-2	6	3	55	2.7
SD-3	6	4	55	3
SD-4	6	6	65	5
SD-5	6	8	65	7
SD-6	6	10	65	9
SD-7	6	12	65	10
SD-9	6	16	65	14

SM

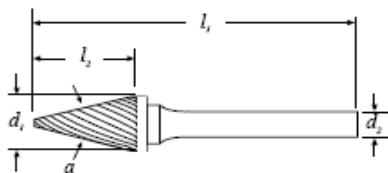

GB

Cone (SM) and Inverted Cone (SN) Shape Burs
Solid Carbide

* 8mm shanks optional. To Order Optional Cuts 4, 3SP, 2, 5 - Specify Quantity, Tool No. & Optional Cut.

Tool No.	Ød1 mm	Ød2 mm	l1 mm	l2 mm
SM-1	6	3	55	11
SM-2	6	6	65	18
SM-3	6	8	65	20
SM-4	6	10	65	20
SM-5	6	12	65	25
SM-6	6	16	65	25

SN

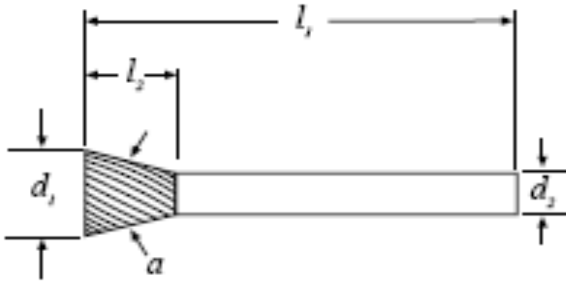

Tool No.	Ød1 mm	Ød2 mm	l1 mm	l2 mm
SN-1	6	3	55	4
SN-2	6	6	65	7
SN-3	6	8	65	10
SN-4	6	10	65	10
SN-5	6	12	65	13
SN-6	6	16	65	16

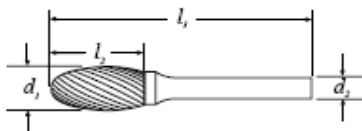

GB

Oval Shape Burs
Solid Carbide

* 8mm shanks optional

To Order Optional Cuts 4, 3SP, 2, 5 – Specify Quantity, Tool No. & Optional cut

ES

Tool No.	Ød1 mm	Ød2 mm	l1 mm	l2 mm
SE-1	6	3	55	7
SE-2	6	6	65	10
SE-3	6	8	65	13
SE-4	6	10	65	16

SE-5	6	12	65	20
SE-6	6	16	65	25

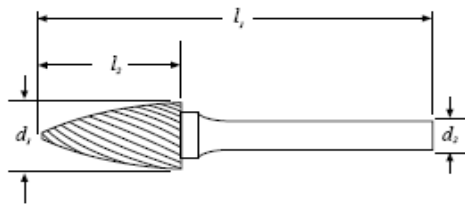

GB

Tree Shape Burs with Pointed End
Solid Carbide

* 8mm shanks optional

To Order Optional Cuts 4, 3SP, 2, 5 – Specify Quantity, Tool No. & Optional cut

ES

Tool No.	Ød1 mm	Ød2 mm	l1 mm	l2 mm
SG-1	6	3	55	13
SG-2	6	6	65	18
SG-3	6	8	65	20
SG-4	6	10	65	20
SG-5	6	12	65	25
SG-6	6	16	65	25

SJ

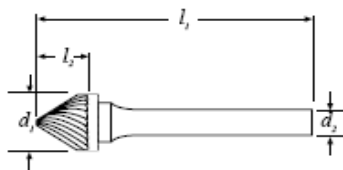

GB

SJ - 60° Cone Shape Burs

SK - 90° Cone Shape Burs

Solid Carbide

* 8mm shanks optional - To Order Optional Cuts

4, 3SP, 2, 5 – Specify Quantity, Tool No. &

Optional cut

ES

Limas rotativas cónica

Metal duro

SJ - Forma cónica a 60°

SK - Forma cónica a 90°

Tool No.	Ød1 mm	Ød2 mm	l1 mm	l2 mm
SJ-1	6	3	55	2.6
SJ-2	6	6	55	5.2
SJ-3	6	8	55	6.9
SJ-4	6	10	55	8.7

SJ-5	6	12	55	10.4
SJ-6	6	16	55	13.8

SK

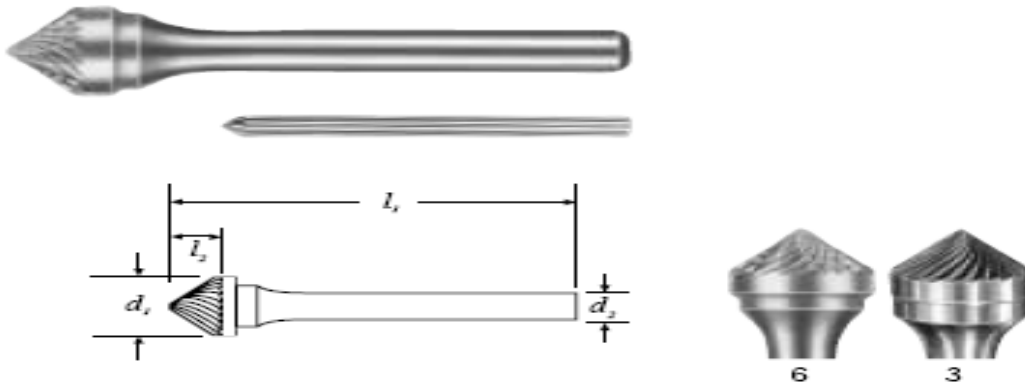

Tool No.	Ød1 mm	Ød2 mm	l1 mm	l2 mm
SK-1	6	3	55	2
SK-2	6	6	55	3
SK-3	6	8	55	4
SK-4	6	10	55	5
SK-5	6	12	55	6
SK-6	6	16	55	8